

Aurelia Bold S 22

Patrick Jouin, 2021



Description

Collection of hand-blown glass pendants in transparent or smoke grey combined with a metal structure in hand finished vintage brass, matte gunmetal or glossy warm white. Two shapes/dimensions and six color combinations with matching canopy. Two integrated LED light sources (direct and indirect) with the ability to turn on/off/dim independently. Both LEDs are available in 2700K or 3000K and are user replaceable. Smart disassembly system to remove the glass diffuser for quick and easy cleaning.

Product features

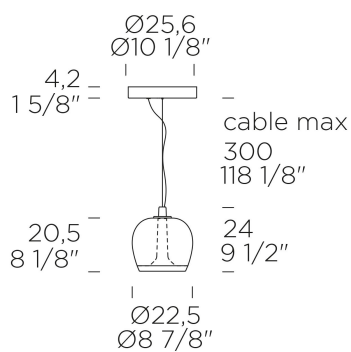

Product code

0011497

Certifications



Structure finish

Pendant

Protection degree

IP 20

Environment

Indoor

Dimensions

118in x 9in x 8in

Materials

glass, metal

Net weight

4kg

Finitura diffusore

smoke grey

Gross weight

5,6kg

Finitura struttura

vintage brass

Light source

Standard

DIRECT LIGHT: LED 1 x 11,6W 1531 lm 3000K CRI?90 + INDIRECT LIGHT: LED 1 x 7,2W 784 lm 3000K CRI?90 (dimmable: Push-dim; 0/1-10V. On request: phase cut dimmer and DALI).

Product available also on these versions

source

DIRECT LIGHT: LED 1 x 11,6W 1531 lm 3000K CRI?90 + INDIRECT LIGHT: LED 1 x 7,2W 784 lm 3000K CRI?90 (dimmable: Push-dim; 0/1-10V. On request: phase cut dimmer and DALI). A++/A

structure finish

 glossy warm white

 matte gunmetal

 glossy warm white

 matte gunmetal

diffuser finish

 smoke grey

 smoke grey

 transparent

 transparent

code

0011501

0011499

0011495

0011493

 vintage brass

 transparent

0011491

Models



Aurelia S 45

Pendant



Aurelia Bold S 22

Pendant